

A group of four people are riding bicycles on a paved street lined with palm trees. From left to right: a man in a pink and white patterned shirt and yellow pants; a woman in an orange cardigan and white shorts; a woman in a colorful striped shirt and white shorts with a basket on her bike; and a man in a yellow hoodie and blue shorts. The scene is bright and sunny.

*Electra*

**LET'S GO!**

But read this first.

ORIGINAL INSTRUCTIONS FOR BIKES AND E-BIKES



## **Here are some tips to help you enjoy your new ride.**

### **Check, check. 1-2, 1-2.**

Before you get on your bike, give it the once over and make sure your tires are properly inflated and the front wheel is secure. Nothing ruins an awesome wheelie like losing a wheel. If you're not sure how the wheel attaches, the details are inside.

### **We like that brain of yours, protect it.**

We know, helmet hair, right? But you know what looks lamer? Concussion hair. Besides, we've got a sweet line of helmets to match your bike.

### **Avoid things that can get stuck in your front wheel.**

A shopping bag in your hand, a purse, rogue sticks. If something gets jammed in there and the front wheel stops suddenly, you're going to have a bad time.

### **Use bike lights on every ride, day and night.**

Use bike lights on every ride, day and night. Use them all the time. It's just like driving these days. People smarter than us have done studies showing lights are the single best way to stand out to motorists, even when the sun is shining.

### **Something sounds or feels weird? Get it checked out.**

Just like planes, bikes are easier to fix before you take off. Electra retailers are there to help.

### **Like a fender after rain, we've got your back.**

If you ever have a problem your local Electra shop can't solve, reach out to: [customercare@electrabike.com](mailto:customercare@electrabike.com) or write Electra President Kevin Cox directly at [kc@electrabike.com](mailto:kc@electrabike.com).

### **Read the rest of this manual.**

Sounds like homework, but it's worth it. Being on the streets since 1993 has taught us a lot of stuff worth sharing.

# How to use this manual

This manual covers all Electra bicycle and electric-assist bicycle (e-bike) models. It contains useful information for the life of your bicycle and e-bike.

For the most up to date information, please refer to the online version of this manual found on [electra.trekbikes.com/electra-manuals](http://electra.trekbikes.com/electra-manuals).

## Read the fundamentals

Read Chapter 1, **Fundamentals**, before you ride your bike.

If you purchased an e-bike, please also read the printed Quick Start Guide supplied with your new bike purchase and the supplemental Electric Bicycle Owner's Manual. These manuals are also available in the **Support** section of [electrabike.com](http://electrabike.com).

## Go online for more great info

You'll find the most current and detailed information including FAQs and how-to videos online at [electrabike.com](http://electrabike.com) and [youtube.com/@ElectraBicycleCompany](https://www.youtube.com/@ElectraBicycleCompany).



[youtube.com/  
@ElectraBicycleCompany](https://www.youtube.com/@ElectraBicycleCompany)

## Keep this manual for reference

This manual shows you how to ride safely, and how and when to do basic inspections and maintenance (Chapter 2). Keep it for the life of your bicycle. We also recommend that you keep your proof of purchase along with the manual in case you need to make a warranty claim.

This manual complies with these standards: EN 15194, ANSI Z535.6; AS/NZS 1927:1998, CPSC 16 CFR 1512, ISO 4210-2 and ISO 8098.

# First things first

We know you want to get out there and ride. Before you do, it's important that you complete steps 1 & 2 below. They won't take long.

## 1. Register your bike

Registration records your serial number (which is important if your bike is ever lost or stolen), and serves as a means of communication with Electra if there are any safety alerts about your bicycle. If you have questions about your bicycle, even years down the line, in just seconds your registration lets us know exactly which bike we're discussing, so we can give you the best service possible.

To register your e-bike, go to the Bike Registration page at [electrabike.com/productRegistration](https://electrabike.com/productRegistration). It's quick and easy.



[electrabike.com/  
productRegistration](https://electrabike.com/productRegistration)

## 2. Read this manual

This manual contains essential safety information for bikes and e-bikes. Even if you've ridden a bicycle for years, it's important that you read and understand the information in this manual before riding your new bicycle. You can read it here or online at [electrabike.com/electra-manuals](https://electrabike.com/electra-manuals).



[electrabike.com/  
electra-manuals](https://electrabike.com/electra-manuals)

Parents or guardians, if this bicycle is for a child or dependent, please make sure he or she understands all safety information in this manual.

E-Bikes: see also the printed e-bike Quick Start Guide supplied with your new bicycle purchase.

# A note about warnings

As you read this manual, you'll see gray warning boxes like this:

 **WARNING!** *Text in a gray box with the safety alert symbol will warn you about a situation or behavior that could cause severe injury or death.*

The reason for these warnings is that we don't want you – or your loved ones, or your bicycle – to get hurt.

We want you to have fun on your bicycle, just like we love to have fun on our bicycles.

We know what it's like to tip over at a stop sign, to bloody our knuckles while fixing a chain, to crash on slick pavement. We've done it all. At best, those mishaps aren't fun. At worst, you could get hurt.

So please pay attention to the warnings. It's our way of letting you know we care about your safety.

# Contents

How to use this manual .....	i
First things first.....	ii
A note about warnings .....	iii

## **Fundamentals**

Important safety information.....	1-1
Important e-bike information .....	1-5
Get to know your bike shop .....	1-7
Before your first ride .....	1-8
Before every ride .....	1-13
Safety precautions .....	1-19
Use conditions & weight limits .....	1-22
Basic riding technique .....	1-24
Riding with a child .....	1-27

## **Caring for your bike**

Safeguard your bike .....	2-1
Maintenance .....	2-5
Inspection .....	2-6
Four easy fixes every rider should know .....	2-10

## **Reference**

Additional resources .....	3-1
Bike diagrams.....	3-2

## CHAPTER 1

# Fundamentals

<a href="#">Important safety information.....</a>	<a href="#">1-1</a>
<a href="#">A bicycle can't protect you in an accident.....</a>	<a href="#">1-1</a>
<a href="#">Know your limits.....</a>	<a href="#">1-1</a>
<a href="#">Know your bike's limits.....</a>	<a href="#">1-1</a>
<a href="#">Handle with care.....</a>	<a href="#">1-2</a>
<a href="#">Think safety.....</a>	<a href="#">1-3</a>
<a href="#">Important e-bike information.....</a>	<a href="#">1-5</a>
<a href="#">Charge the battery.....</a>	<a href="#">1-6</a>
<a href="#">Get to know your bike shop.....</a>	<a href="#">1-7</a>
<a href="#">The ultimate resource.....</a>	<a href="#">1-7</a>
<a href="#">There's a shop for every rider.....</a>	<a href="#">1-7</a>
<a href="#">Before your first ride.....</a>	<a href="#">1-8</a>
<a href="#">Ride the right size bike.....</a>	<a href="#">1-8</a>
<a href="#">Tire clearance.....</a>	<a href="#">1-9</a>
<a href="#">Bed-in your disc brakes.....</a>	<a href="#">1-12</a>
<a href="#">Before every ride.....</a>	<a href="#">1-13</a>
<a href="#">Pre-ride checklist.....</a>	<a href="#">1-13</a>



<u>Safety precautions</u> .....	1-19
<u>Gear up</u> .....	1-19
<u>Ride smart</u> .....	1-19
<u>Avoid misuse</u> .....	1-20
<u>Avoid hazards</u> .....	1-20
<u>Respect the weather</u> .....	1-21
<u>Listen to your bike</u> .....	1-21
<u>Plan ahead</u> .....	1-21
<u>Follow the rules on and off-road</u> .....	1-21
<u>Use conditions &amp; weight limits</u> .....	1-22
<u>Basic riding technique</u> .....	1-24
<u>Turning and handling</u> .....	1-24
<u>Stopping</u> .....	1-24
<u>Shifting gears</u> .....	1-25
<u>To shift with an internal gear hub (IGH)</u> .....	1-26
<u>Pedaling</u> .....	1-26
<u>Riding with a child</u> .....	1-27
<u>Towing or carrying a child on your bike</u> .....	1-27
<u>Accompanying a child riding their own bike</u> .....	1-28

# Important safety information

Read this important safety information before riding your bicycle.

## A bike can't protect you in an accident

The most common cause of injury on a bicycle is falling. In a crash or impact, it is not uncommon for your bicycle to sustain damage and for you to fall. Cars have bumpers, seat belts, air bags, and crumple zones. Bicycles do not. If you fall, your bicycle cannot prevent injury.

If you are involved in any kind of impact, crash, or accident, check yourself thoroughly for injuries. Then have your bicycle thoroughly inspected by your bike shop before you ride it again.

## Know your limits

A bicycle can be dangerous, especially if you try to ride beyond the limits of your ability. Know your skill level and don't ride beyond it.

## Know your bike's limits

### Use conditions

Your bicycle is made to withstand the stress of "normal" riding within specific use conditions (see Use conditions section). If you misuse your bicycle by riding outside those conditions, it can be damaged by stress or fatigue. (You'll see the word "fatigue" frequently in this manual. It means the weakening of material over time due to repeated load or stress.) Any damage can drastically reduce the life of the frame, fork, or other parts.

### Lifespan

A bicycle is not indestructible, and its parts will not last forever. Our bicycles are made to withstand the stress of "normal" riding because those stresses are well known and understood.

However, we cannot predict the forces that might occur if you use your bicycle in competition, if you ride in extreme conditions, if it is involved in a crash, if it is used for rentals or for commercial purposes, or if it is used in other ways that apply high stress or fatigue loads.

With damage, the life of any part can be drastically reduced and may fail without warning.

The safe life of a part is determined by its construction, materials, use, maintenance, rider weight, speed, terrain, and environment (humidity, salinity, temperature, etc.), so it is not possible to give an accurate timetable for replacement.

Any crack, scratch, or change of color in a high-stress area indicates the part (including the frame or fork) has reached the end of its life and should be replaced. If you are not sure or you don't feel comfortable inspecting or repairing your bicycle, consult your bike shop.

In some cases, a lighter frame or part has a longer life than a heavier one. However, regular maintenance, frequent inspections, and frequent replacement of parts are necessary for a lightweight, high-performance bicycle.

 **WARNING:** *A bicycle is subjected to wear and high stress. Different materials and parts may react to wear or stress fatigue in different ways. If the design life of a part has been exceeded, it may suddenly fail.*

## Handle with care

Some parts of your bicycle can injure you if mishandled. There are sharp points, for example, on the teeth of the chainrings and some pedals. Brakes and their parts get hot. Rotating wheels can cut skin and even break bones. Clamps and pivoting parts such as brake levers can pinch, as can the chain where it runs onto sprocket teeth.

E-bike components are especially vulnerable. Electric cables, connectors, battery dock, battery, and the remote can be easily damaged if handled incorrectly.

## Think safety

Stay tuned to your environment and avoid dangerous situations which are usually obvious (traffic, obstacles, drop-offs, and so on), but sometimes are not. Many of those situations are shown in this manual.

Some of the high-risk stunts and jumps seen in magazines or videos are very dangerous; even skilled athletes get severe injuries when they crash (and they do crash).

Modifications to your bicycle can make it unsafe. Each part of your new bicycle has been carefully chosen and approved. The safety of accessory or replacement parts and especially how those parts attach and interface with other parts of the bicycle is not always apparent. For this reason, you should only replace parts with original equipment or parts that are approved. If you are not sure what parts are approved, ask your bike shop.

Be sure to read, understand, and follow the instructions that accompany the products you purchase for your bicycle.

Examples of modifications include this partial list:

- Physically altering existing parts (sanding, filing, drilling, etc.)
- Removing safety equipment such as reflectors or secondary retention devices
- Using adapters for brake systems
- Adding a motor or engine
- Installing accessories
- Changing parts

**⚠ WARNING:** Failure to confirm compatibility, properly install, operate and maintain any component or accessory can result in serious injury or death.

**⚠ WARNING:** Changing the components on your bike with other than genuine replacement parts may compromise the safety of your bicycle and may void the warranty. Check with your Electra retailer before changing the components on your bike.

**⚠ WARNING:** Any accessory or component attached to, on or near a rotating wheel poses a risk of contacting or stopping the wheel, leading to a crash resulting in serious injury or death. Before every ride check to ensure that all such accessories and components, and the fasteners used to attach them, are securely mounted to your bicycle.

**⚠ WARNING:** Stopping the front wheel suddenly can cause the bike to stop unexpectedly and abruptly. This may cause the rider to be launched over the handlebars, resulting in serious injury or death.

New components or accessories could interfere with the operation of your bicycle's controls, including the steering, shifting, braking, pedaling, or rotation of the wheels. Always verify that any new product you purchase for your bicycle does not interfere with these functions.

**⚠ WARNING:** If your bicycle's controls are impaired or compromised due to the use of incompatible accessories or components, the bicycle may stop unexpectedly, or you may lose control of your bicycle and crash, resulting in serious injury or death.

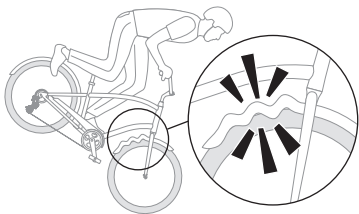

An unauthorized or incorrectly mounted fender can cause the bike to stop suddenly.

# Important e-bike information

It is important to read this manual, the printed e-bike quick start guide that came with your bike, and the supplemental Electric Bicycle Owner's Manual carefully before you ride your new electric bike.

- There's good stuff in each manual about your e-bike.
- We're partners in protecting the earth, so you need to properly use, maintain, and dispose of electrical components.

The A-weighted emission sound pressure level at the driver ears is less than 70 dB(A).

In addition to the operation of your e-bike section, we recommend you read the **Important to read before the first ride** section of the supplement.

An electric bike has hidden wiring inside the frame and has other critical parts like the drive unit and battery pack. When mounting additional, non-standard accessories (e.g. a bottle cage or range extender), be sure not to impact the wiring or battery pack (e.g. using too long or pointed bolts). This might cause a short circuit to the electric system and/or damage to the battery. See figure at right.

Any e-bike or e-system modifications can make the bike and the e-system unsafe and may void the warranty.

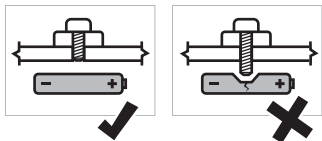

**⚠ WARNING:** A short circuit in the electric system and/or damage to the battery might lead to over-heating. In an extremely rare case, a battery pack that has been severely impacted could potentially catch fire.

**⚠ CAUTION!** Any unauthorized modification (tampering) of your e-bike's drive system is prohibited. If you suspect your e-bike has been tampered with, or you experience a change in the speed at which your drive assistance cuts off, stop riding and contact an authorized Electra retailer for assistance.

## Charge the battery

The battery is supplied partially charged. For best performance, fully charge the battery before riding your e-bike.

 **WARNING:** *Be safe. Follow these safety warnings when charging your battery:*

- *Only charge the battery with the charger that came with your e-bike. Using the wrong charger risks the life of the battery and presents a potential fire hazard.*
- *Only use the charger in dry, indoor areas.*
- *Do not leave a charging battery unattended.*
- *When the battery is fully charged, disconnect the charger from the battery and wall socket.*

# Get to know your bike shop

The best way to ensure many happy hours of trouble-free biking is to build a relationship with your favorite bike shop.

## The ultimate resource

This manual contains lots of valuable information about your bicycle – and there's even more in the Support section of [electrabike.com](http://electrabike.com).

But a manual or a website can't fix a flat, tune your derailleur, correct your saddle height, pour you a cup of coffee, or talk endlessly about that one time when you almost won that one thing.

Locally owned bike shops are the heart and soul of biking. Here's just a sampling of what they offer:

### Knowledgeable staff

Bike shop staff aren't just sales-people. They're riders who use and understand the products they sell.

### The right fit

Your shop can set up and adjust your bike to fit you, your riding style, and your preferences.

## Professional mechanics

Service staff at your shop will keep your bike or e-bike in tip-top shape season after season.

## Warranty service

If you have an issue with a product we sell, your bike shop is committed to making it right.

## There's a shop for every rider

We work with over 3,000 local bike shops in the US and thousands more worldwide. Some specialize in racing, some cater to commuters, some are all about the trails – and many offer something for everyone.

If you don't already have a favorite shop, the best place to find one is Bike Shops at [electrabike.com](http://electrabike.com).



# Before your first ride

Make sure your bicycle is ready for use before your first ride.

## Ride the right size bike

Almost all Electra models feature our Flat Foot Technology® frame geometry. One size typically fits most, but your shop will help you find the Electra bicycle that fits you best.

Raise or lower the saddle to just below hip height to allow your feet to slightly touch the ground flat-footed while supporting your entire weight on the saddle. Make sure your legs are in a straight vertical position and your knees are NOT bent (Figure 1.1). In most cases, this will give you proper riding leg extension. If you prefer more extension, raise the saddle slightly.

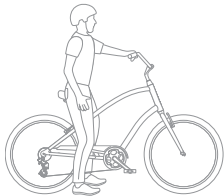

Figure 1.1: Correct ride height.

## Stay within the weight limit

Your bicycle has a weight limit. See the [Use conditions](#) section for general guidelines.

To avoid damage to the seatpost or bike frame, do not position the saddle beyond the minimum insertion line on the seatpost or seatmast (Figure 1.2). If you can't properly position your saddle, see your bike shop.



Figure 1.2: The seatpost minimum insertion line.

**⚠️ WARNING:** *With the seat post fully compressed, the saddle in the rearmost position, and a fully compressed rear suspension, the rear tire may interact with the saddle. To alleviate this, adjust your saddle up and forward.*

## Adjust your handlebar and stem to a comfortable height

Handlebar position is important for control and comfort. You point the handlebar and the bike follows.

Special tools and training are necessary to align, adjust, and torque your stem, so only your bike shop should do this. Do not attempt to make the adjustments yourself as these changes may also require adjustments to the shift levers, brake levers, and cables.

**⚠️ WARNING:** *An incorrect headset and stem assembly, and incorrect torque can cause damage to the fork's steerer tube, possibly causing the tube to break. If the steerer tube breaks, you could fall.*

## Get to know your bike

For the most possible enjoyment from your bicycle, familiarize yourself with:

- Pedals
- Brakes (levers or pedals)
- Shifting (if equipped)

You will enjoy yourself more if you have a comfortable and confident ride.

## Tire and rim width/diameter

Wheel rims and tires come in a wide range of diameters and widths (see below). The nominal diameter of the rim (1) must match the nominal diameter of the tire (2), and the width of the rim (3) must be compatible with the width of the tire (4).

Always follow the rim manufacturer's recommendations concerning tire models and sizes that are compatible with your specific rims.

**⚠️ WARNING:** *Failure to use a compatible tire and rim combination can cause the tire to unexpectedly lose pressure and detach from the rim, resulting in a crash causing serious injury or death. Ensure the components are compatible according to the component manufacturers before installation.*

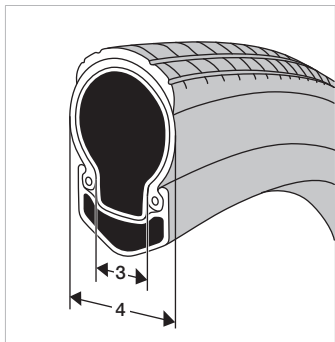
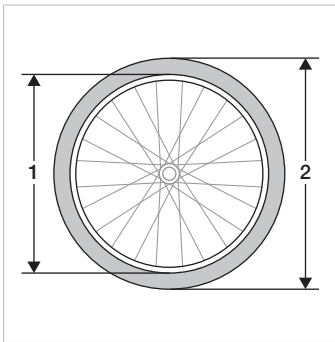

## Tire clearance

The diameter and width of the original equipment wheels and tires on your bicycle have been selected to ensure they provide adequate clearance between the rotating tire and wheel, and the frame, fork, or other components. Any change to your wheels or tires can affect this clearance.

Tires that are marked as being the same size may have different widths when installed, properly inflated and mounted on your bike. Always verify your tire clearance with the tires mounted and fully inflated even if the replacement tires are marked as being the same size as the tires that are being replaced.

Minimum clearance between a properly inflated tire and any part of the bike typically should be at least 6mm (see below). Please refer to your local Electra bike shop for additional information about tire clearance.

Always maintain enough clearance between the rotating tire and rim (see next page), and the frame, fork, or other components. Regularly inspect the frame and fork for damage, as well as the area around the wheel for debris or objects that could become stuck.

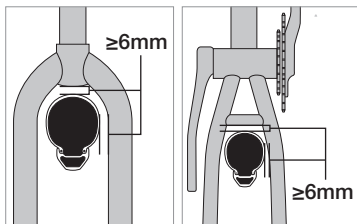

When riding your bike, the tires must not be able to contact the fork, frame or any components, or the wheels are subjected to flex from side loads.

**⚠ WARNING:** *Inadequate tire clearance can allow debris or objects to become trapped or cause the wheels to stop unexpectedly, which could cause a crash resulting in serious injury or death.*

**⚠ WARNING:** *Inadequate tire clearance that results in contact between the tire and any part of the bicycle can result in damage which can lead to failure, which could cause a crash resulting in serious injury or death.*

*If you have mounted additional accessories or components on your bicycle, particularly fenders, these products may require additional clearance between the tire/ wheel and the accessory or component. You should verify the required clearance for any accessory or component mounted on your bicycle with the manufacturer, and do not use the product if the specified clearance cannot be maintained.*

**⚠ WARNING:** *Any accessory or component attached to, on or near a rotating wheel poses a risk of contacting or stopping the wheel, leading to a crash resulting in serious injury or death. Before every ride check to ensure that all such accessories and components, and the fasteners used to attach them, are securely mounted to your bicycle.*

**⚠ WARNING:** *Stopping the front wheel suddenly can cause the bike to stop unexpectedly and abruptly. This may cause the rider to be launched over the handlebars, resulting in serious injury or death.*

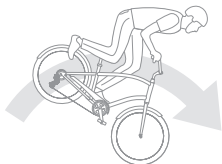

## Bed-in your disc brakes

New disc brakes require a bed-in (burn-in) process. The process helps ensure consistent and powerful braking feel, along with the quietest braking in most riding conditions.

**⚠ WARNING:** *The bed-in process requires you to perform heavy braking. You must be familiar with the power and operation of disc brakes. Braking heavily when not familiar with the power and operation of disc brakes could cause you to crash, which could lead to serious injury or death. If you are unfamiliar with disc brakes, you should have the bed-in process performed by your bike shop.*

**⚠ WARNING:** *Do not perform the bed-in process while transporting people or cargo.*

1. On a flat surface, while sitting on the saddle, accelerate the bike a moderate speed.
2. Then firmly apply the brakes until you are at walking speed. Repeat approximately twenty times.

**⚠ WARNING:** *The braking force will increase with each cycle of acceleration and braking. Apply less pressure to the brake levers as less pressure is required to slow the bike to a walking speed. Braking heavily could cause you to crash.*

3. Accelerate the bike to a faster speed, then firmly apply the brakes until you are at walking speed. Repeat approximately ten times.
4. Allow the brakes to cool prior to any additional riding.
5. See your bike shop if you need to adjust the brake cable tension after the bed-in process.

# Before every ride

Before riding your bicycle, perform a safety check on level ground and away from traffic. If any part doesn't pass the safety check, fix it or have your bike serviced before riding.

## Pre-ride checklist

### □ Check the handlebar

- Make sure the bar is at 90 degrees to the wheel.
- Check that the handlebar is tightened sufficiently so that it will not twist out of alignment and does not rotate in the stem.
- Make sure that no cables are pulled or caught when you turn the handlebar from side to side.

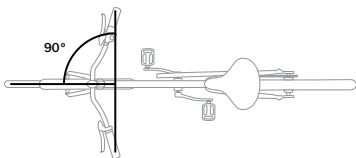

### □ Check the handlebar grips

Make sure the handlebar grips are secure and in good condition. If your grips are loose, or have cuts, tears or worn out areas, have your bike shop replace them.

**▲ WARNING:** *Loose or damaged handlebar grips or unsecured handlebar extensions can cause you to lose control, causing a crash resulting in serious injury or death.*

Some handlebars are equipped with grips that lock on with a mechanical connection. They must have adequate space to properly align the grips with the handlebar ends and be properly plugged so no portion of the handlebar end is exposed. Locking grips must be properly tightened to avoid movement.

**▲ WARNING:** *Improperly secured locking grips could lead to a loss of control or a crash, resulting in serious injury or death.*

### □ Check the handlebar ends

Make sure the ends of the handlebar and any extensions are plugged. If not, have your bike shop plug them before you ride. If the handlebars have bar end extensions, make sure they are clamped according to the handlebar and extension manufacturer's instructions. Make sure your handlebar, extensions, grips, brake and shifting controls are secure and allow the safe operation of your bicycle, including the ability to steer, brake, and shift without any interference.

**▲ WARNING:** *The ends of handlebars and handlebar extensions must be plugged at all times. Unplugged handlebars or extensions can cut or impale you even in a minor crash, resulting in serious injury or death.*

### □ Check the saddle and seat post

- Make sure the saddle is in line with the center of the bike.
- Check that the saddle rails or collar is tightened sufficiently so that it will not twist out of alignment, or move or tilt up and down.

### □ Check the wheels

- Check rims and spokes for damage.

Give the wheel a spin. It should spin straight through the fork (front) and chainstays (rear), and not contact the brake pads (rim brakes).

- Check that the axles are fully seated in the dropouts.
- Lift your bicycle and hit the top of the tire with a solid blow. The wheel should not come off, be loose, or move from side to side.

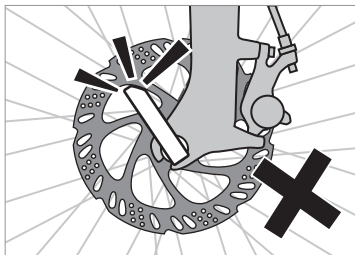

- If your wheel is equipped with a quick-release, make sure the lever is properly closed and positioned: does not touch the fork or an accessory part (rack, fender, bags, etc.), and does not interfere with the spokes or disc brake system as the wheel rotates.

**⚠ WARNING:** Securely clamping the wheel with a quick release system takes considerable force. If the wheel is not properly secured, the wheel can become loose or fall off causing serious injury.

The adjustment nut should be tightened enough that the closing force of the quick-release lever leaves an imprint in your palm. If the lever does not close properly, due to contact with the fork or accessory, reposition and close the lever.

If the lever touches anything, it may not be closed. If you have a quick-release axle assembly (not a thru axle), and proper closure is not possible, remove the quick-release axle and place the lever on the opposite side of the bicycle. Adjust and close properly or contact your bike shop for replacement.

**⚠ WARNING:** A wheel quick-release lever that is not correctly adjusted and closed can move and catch in spokes or a brake rotor. It may also allow the wheel to be loose or come off unexpectedly. This could cause loss of control, a fall, and may result in serious injury or death. Before every ride, make sure the quick-release is adjusted and closed correctly.

**⚠ WARNING:** A wheel attachment device that is not properly secured can allow the wheel to loosen or come off, suddenly stop the wheel, decrease your control, and cause you to fall, resulting in serious injury or death. Ensure the axle is not interfering with any part of the bicycle and is fully secured.

### Bolt-on wheel attachment

Check that the axle is properly adjusted and fully seated in the dropouts.

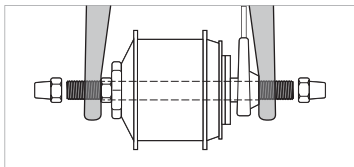

### Thru axle wheel attachment

Check that the axles are properly adjusted and fully secure in the dropouts.

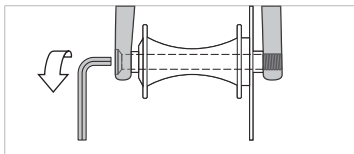



Make sure your bike shop has given you the manufacturer's instructions, and follow those when installing or removing a thru axle wheel. If you don't know what a thru axle is, ask your bike shop.

The thru axle length, diameter, and thread pitch must match the specifications of your frame, fork, and wheel hubs. Always install or remove your wheel in accordance with the thru axle manufacturer's instructions and consult the manufacturer if you have questions.

If you intend to replace the thru axle, make sure the new thru axle is compatible with your bicycle. Do not remove the thru axle from your bicycle and use it on a different bicycle, as it may not be compatible and will not properly secure your wheel.

The thru axle is inserted through the unthreaded hole in the frame or fork's dropout, through the wheel hub, and is threaded directly into the opposing dropout by tightening the thru axle.

#### **Check the tires**

Use a tire pump with a gauge to make sure your tires are inflated within the recommended pressure range. Do not exceed the pressure limit as stated on the side of the tire or rim; whichever is lowest.

**NOTE:** It is better to use a hand or foot pump than a service station pump or electric compressor. The latter are more likely to allow for over-inflation, which can cause the tire to blow out.

 **WARNING:** *Never inflate a tire beyond the maximum pressure marked on the tire's sidewall. Exceeding the recommended maximum pressure may blow the tire off the rim or damage the wheel rim during installation or while riding, resulting in a loss of control or crash causing serious injury or death, as well as damage to the tire, tube, and/or wheel rim.*

 **WARNING:** *Never ride a tire inflated below the minimum pressure marked on the tire's sidewall. Tire pressure below the minimum may cause a flat tire and/or the tire to detach from the rim while riding, resulting in a loss of control or crash causing serious injury or death, as well as damage to the tire, tube, and/or wheel rim.*

#### **Check the brakes**

- While standing still, make sure you can apply full braking force without the

brake lever touching the handlebar.  
(If the lever touches, your brakes may need adjustment.)

**⚠ WARNING:** Brake force applied to the front wheel suddenly or too fully could lift the rear wheel off the ground. This could decrease your control and cause you to fall. For best results, apply both brakes at the same time.

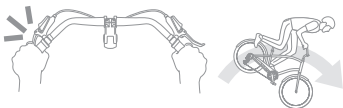

Check that the front wheel brake is working properly. Ride the bike at slow speed and apply the front wheel brake. The bike should come to an immediate stop.

- For rim or disc brakes, repeat the process with the rear wheel brake.
- For coaster brakes, start with the back pedal crank slightly higher than horizontal. Apply pressure downwards on the back pedal. When you move the pedal downward, the brake should engage.

## □ Check the chain

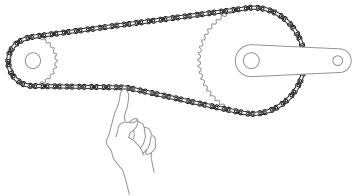

- Make sure your chain or belt has the correct tension so that it can't fall off. If you're unsure of the correct tension, see your bike shop.
- Check that the chain has no kinks, rust, broken pins, plates, or rollers.
- There should be between 6-12mm (0.25-0.50 in) total vertical movement in the middle of the chain.

## □ Check the cables

- Make sure all cables and housings are properly secured to the frame or fork so that they cannot interfere with or get caught on moving parts.

### Check reflectors, lights, and accessories

- Check that reflectors are clean and positioned correctly, i.e. perpendicular with the riding direction for front and rear reflectors and in the plane of the wheel for spoke reflectors.

**NOTE:** Reflectors function only when light shines on them and are not a substitute for lights.

- Make sure your front and rear lights and any other accessories are securely attached, properly positioned, and working properly.
- Aim your front light slightly downward to prevent glare for oncoming traffic
- Make sure your batteries are charged.

### Check your e-bike battery and remote

- With an e-bike, check that your battery is locked in the dock and fully charged, and your remote and e-bike system are functioning properly.

### Check your pedals

- Make sure your pedals and shoes are clean and free of debris that could affect your grip or interfere with the pedal system.
- Grab your pedals and crank arm and wiggle to see if there's any looseness. Also spin the pedals to make sure they rotate freely.

### Check a locking headset (if installed)

- Make sure to unlock your headset before you ride.

**⚠ WARNING:** A locked headset can limit your ability to turn the handlebar. This may lead to loss of control, injury or death. Unlock your headset before riding for full control of your bicycle.



# Safety precautions

Follow these essential safety precautions to reduce your risk of harm when riding your bicycle.

## Gear up

- Always wear a helmet when riding your bicycle to reduce the risk of head injury in an accident. Make sure your helmet fits you properly and meets the required safety standards.
- Dress appropriately. Loose clothing or accessories can get caught in your wheels or other moving parts and cause you to fall (e.g. pants leg in the chainring).
- Make sure all loose straps and accessories are secured (bikepacking harness, panniers, etc.).
- Increase your visibility by wearing fluorescent apparel during daylight, and reflective apparel at night. On a bike, the unique up and down pedaling motion is what makes you recognizable on the road. At night, highlight your feet, ankles, and legs with products that feature reflective materials. During daylight, wear fluorescent socks, shoes, covers, or warmers.

- Use front and rear lights, day and night.
- Make sure your reflectors are clean and properly positioned.

 **WARNING:** Reflectors, which function only when light shines on them, are not a substitute for lights. Riding in dark conditions or at times of poor visibility without adequate lighting is extremely hazardous.

## Ride smart

Know your skill level and do not ride above it.

- When riding, do not stare at the computer or your phone for too long. You could hit an obstacle causing loss of control and a fall.
- Do not ride too fast. Higher speed creates higher risk, and results in higher forces if a crash occurs. You may be surprised at the power of an e-bike.
- Do not ride hands-free. Always keep at least one hand on the handlebar.

- Do not ride double except on a tandem bicycle.
- Do not ride while intoxicated or while using medications that can make you drowsy or less attentive.
- Do not ride in large groups. Riding close to other riders reduces visibility with the road and can cause you to lose control of your bicycle. Also, large groups of cyclists can cause problems for other users of the roadway.
- Do not ride in a manner not specified for your bicycle type (see section [Use conditions & weight limits on page 1-22](#)).

**E-BIKE NOTE:** Be aware that other road users do not expect that an e-bike can ride faster than a normal bike. Riding faster may also increase the risk of an accident.



**WARNING:** *You add to your risk of injury when you use your bicycle in an incorrect manner. Misuse can add stress to your bike. High stress can cause the frame or a part to break and increase your risk of injury. To decrease your risk of injury, use your bicycle in the manner for which it was designed.*

## Avoid misuse

Examples of misuse include jumping your bicycle; riding over sticks, debris, or other obstacles; performing stunts; riding in severe off-road terrain; riding too fast for conditions, or riding in an unusual manner. These and other misuses add to the stress on each part of your bicycle.

## Avoid hazards

Watch for cars, pedestrians, and other cyclists. Assume others do not see you, and be prepared to avoid them or their actions such as opening a door in your path.

Ride carefully when off-road. Ride only on the trails. Do not ride over rocks, branches, or depressions.

Do not ride with a loose object or pet's leash attached to the handlebar or other part of your bicycle.

Watch for and avoid road hazards like potholes, drain grates, soft or low shoulders, or debris that could impact your wheels, make your wheels slide, cause your wheels to "lock up," or catch your wheels in a rut, all of which could cause you to lose control. If you're uncertain of the road conditions, walk your bike.

When you cross railroad tracks or drain grates, approach them carefully and cross them at a 90-degree angle to keep your wheels from getting caught in the ruts.

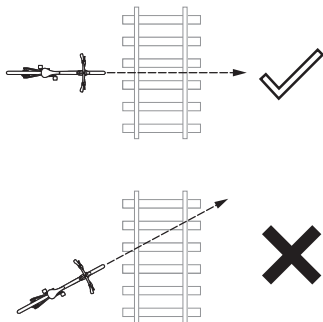

## Respect the weather

Take extra precautions when you ride in wet or snowy weather, because the grip of your tires is greatly reduced.

Braking distances increase in wet weather. Apply your brakes earlier and use extra caution than when riding in dry conditions.

## Listen to your bike

If your bicycle behaves in an unusual manner (it shakes or wobbles, for example), or you hear an unusual noise, immediately stop riding the bicycle and identify the problem.

After any crash or impact, have your bike shop thoroughly inspect your bicycle. Damage to your bicycle may not be readily visible. Repair any problem before riding again or take the bicycle to your bike shop for service.

## Plan ahead

It's a real drag to have a flat tire or other mechanical problem when out on an enjoyable bike ride. Carry a pump, spare inner tube, patch kit, tools, and spare batteries, or chargers for your lights and batteries. Be ready to fix your bike so you can return safely from your ride.

## Follow the rules on and off-road





It is your responsibility to be aware of the laws that apply where you ride. Observe all laws and regulations regarding e-bikes, bicycle lighting, riding on roads or paths, helmets, child carriers, and traffic.

# Use conditions & weight limits

Your bicycle has a frame sticker that indicates its use condition. Ride only in the use condition specified for your bicycle type.



## Frame sticker

Check your frame for the use condition sticker and/or the following Electrically Power Assisted Cycles (EPAC) sticker:

EU Fast Electric Bicycle (Speed EPAC) 45 kmph (28 mph)	EU EPAC ISO label, CE specific to model	US EPAC ISO label, Class label
<div data-bbox="142 440 342 547" style="border: 1px solid black; padding: 5px;"> <p>Diamant Fahrradwerke GmbH L1e-B e1*168/2013*XXXXX WID2XXXXXXXXXXXXXX -- dB(A), --- min<sup>-1</sup> 0.3 kW 45km / h max 145 kg</p> </div> <div data-bbox="150 552 335 588">  </div> <p data-bbox="142 588 342 619"><b>RECOMMENDED TYRE PRESSURE BAR (PSI), COLD</b></p> <div data-bbox="142 622 342 643" style="border: 1px solid black; padding: 2px;"> <p><b>FRONT 2.4 (35) REAR 2.4 (35)</b></p> </div>	<div data-bbox="453 381 581 653" style="border: 1px solid black; padding: 5px;"> <p>2023 250 W </p> <p>max 250 kg <span style="margin-left: 100px;">max 25 km/h</span></p>  <p>max 160 kg Bike 25 kg</p> <hr/> <p>max 160 kg Biketeupe BV / Trek Benelux Ceintuurbaan 2-20C 3047 LG Harderwijk The Netherlands</p> <p><b>UK CA</b></p> <p>Trek Bicycle Corporation Ltd. 9 Sherbourne Drive, Tibbrosok, Milton Keynes, UK MK7 0HX</p> </div> <div data-bbox="446 686 588 764" style="text-align: center;">   <b>EN 15194</b>  <b>City/Trekking EPAC</b> </div>	<p data-bbox="743 391 833 453" style="text-align: center;"><b>Class I</b> <b>Max 250 W</b> <b>Max 20 mph</b></p> <p data-bbox="736 505 841 567" style="text-align: center;"><b>Class 3 E-bike</b> <b>Max 750 W</b> <b>Max 28 mph</b></p> <div data-bbox="715 622 860 700" style="text-align: center;">   <b>EN 15194</b>  <b>City/Trekking EPAC</b> </div>

**⚠ WARNING:** *If your use of a bicycle applies more stress than the Use Condition for which it is intended, the bicycle or its parts can be damaged or broken. A bicycle that has damage could decrease your control and cause you to fall. Do not ride in use conditions that apply more stress than the limits of the bicycle. If you are not sure of the limits of the bicycle, consult your bike shop.*

**Weight limit** = rider + bicycle + gear/cargo.

Condition	Terrain	Weight limit	Bicycle type or definition
	Riding for children. A child should not ride without the supervision of a parent. Children should not ride near slopes, curbs, stairs, drop-offs, pools; or areas that automobiles use.	36kg (80lb)	<p>Maximum saddle height of 635mm</p> <p>Usually a bicycle with 12", 16", or 20" wheels; a child's tricycle; and includes a trailer bicycle</p> <p>No quick-release wheel attachment systems</p>
	Riding on a paved surface where the tires are always on the ground.	125kg (275lb)	<p>Road bicycle with drop-type handlebar</p> <p>Triathlon, time trial, or speed bicycle</p> <p>Cruiser with large, 26" tires and swept-back handlebar</p> <p>Road electric-assist bicycle with drop-type handlebar</p>
		136kg (300lb)	Select pedelec electric-assist bicycle (e-bikes)
		160kg (350lb)	Select bikes and pedelec electric-assist bicycles (e-bikes)
	<p>Riding in Condition 1, plus gravel roads and groomed trails with low-angle grades.</p> <p>Drop-offs of less than 6" (15cm).</p>	160kg (350lb)	Select mountain, gravel, and pedelec electric-assist bicycle (e-bikes)
		80kg (175lb)	Mountain or hybrid bike with 24" wheels
		125kg (275lb)	Cyclocross or gravel bicycle:: drop-type handlebar, knobby 700c tires, and cantilever or disc brakes
		136kg (300lb)	Hybrid or DuoSport bicycle with tires wider than 28c and flat handlebar
			Standard pedelec electric-assist bicycle



# Basic riding technique

Use the following tips and techniques to get the most out of your riding experience.

## Turning and handling

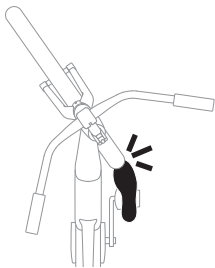

Be careful of “toe overlap.” When you turn the handlebar at very slow speeds, your foot could overlap or touch the front wheel or fender. Do not pedal when you ride slowly with the handlebar turned.

Wet, debris-strewn, or uneven pavement will affect the handling of your bicycle. Paint (crosswalks, lane lines) and metal surfaces (grates, manhole covers) can be especially slippery when wet. Try to avoid sudden changes in direction on less-than-ideal surfaces.

## Stopping

Always ride with a safe distance between you and other vehicles or objects to give yourself adequate room to stop. Adjust distances and brake forces to suit riding conditions and speeds.

For safest braking, use your brakes smoothly and evenly. Look ahead and adjust your speed in advance to avoid hard braking.

Different bikes have different brake systems and different levels of brake power depending on their use condition (see Use conditions & weight limits section). Be aware of your bicycle’s braking power and don’t ride beyond it. If you want more – or less – braking power, consult your bike shop.

Wet, debris-strewn, or uneven pavement will affect how your bike reacts to braking. Take extra care when braking under less-than-ideal road conditions. Keep it smooth, and allow more time and distance for stopping.

## Coaster brakes

*Parents or guardians: explain this to your child or dependent.*

If your bicycle has a coaster brake (a brake activated by the pedals), apply the brake by pedaling backwards.



For greatest braking force, the crank arms should be horizontal when you apply the brake. The crank will rotate some before the brake starts to work, so start to apply the brake with the rear pedal slightly higher than horizontal.

## Hand brakes

Before riding, make sure you know which brake lever controls which brake (front or rear) as these may be set up specific to market regulations.

If you have two hand brakes, apply both brakes at the same time.

The front brake provides more stopping power than the rear, so do not use it too forcefully or too abruptly. Gradually add pressure to both brakes until you slow to the desired speed or stop.

If you must stop quickly, shift your weight back as you apply the brakes to keep the rear wheel on the ground.

**⚠ WARNING:** *Brake force applied to the front wheel suddenly or too fully could lift the rear wheel off the ground or cause the front wheel to slide out from under you. This will decrease your control and cause you to fall.*

Some front brakes include a 'modulator', a device that makes application of the front brake more gradual.

## Shifting gears

The gears on your bicycle allow you to pedal comfortably in different conditions – like riding up a hill, pedaling into a headwind, or riding fast on flat terrain. Select the gear that is most comfortable for the conditions; a gear that lets you pedal at a constant rate.

There are two shifting systems on most bicycles: the derailleur which is external, and the internal gear hub (IGH). Use the proper technique for your setup.

Different shifters and derailleurs function differently. Get to know your system.

## To shift with a derailleur

**⚠ WARNING:** *Improper derailleur shifting technique could cause your chain to jam or come off, causing you to lose control and fall.*

A derailleur moves your chain from one gear to another. You shift gears by changing the position of a shift lever (also called a shifter), which controls the derailleur. On most bicycles the left shifter controls the front derailleur and the right shifter controls the rear derailleur.

Shift gears only when the pedals and chain are moving forward.

Decrease the force on the pedals as you shift gears. Reduced chain tension helps the chain shift gears quickly and smoothly, which decreases chain, derailleur, and gear wear.

Use only one shifter at a time.

Do not shift gears when you ride over bumps to prevent dropping or jamming the chain or missing a gear.

## To shift with an internal gear hub (IGH)

When you shift gears, coast (do not pedal). Tension on the chain prevents the correct operation of the gear change mechanism and could damage the mechanism.

With most IGH systems you can shift while the bike is not moving – for example, you could shift into a lower gear at a stop sign for easier startup.

## Pedaling

Although there are different pedal systems available, all Electra bicycles come standard with flat pedals.

### Flat

Flat pedals are exactly what they sound like. They don't require special footwear, and your feet are free to move on and off the pedal.

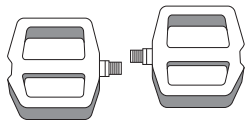

# Riding with a child

Take these precautions to give young riders the safest, best experience possible.

## Towing or carrying a child on your bike

**⚠️ WARNING:** Adding a child carrier to your bicycle adds weight and raises the center of gravity, which can make the bike take longer to stop, become hard to control, and be easier to tip over. Do not leave your child unattended in a child carrier. Take extra care when balancing, braking, and cornering with a child carrier. Tipping over or loss of control may lead to severe injury or death to you or your child passenger.

**⚠️ WARNING:** Certain bicycle racks are not intended for use with child carriers. If you are unsure, contact your Electra bike shop.

**⚠️ WARNING:** Child carrier manufacturers have different mounting systems which may or may not be compatible with certain bicycle racks. If you are unsure, contact the child carrier manufacturer.

**⚠️ WARNING:** If you attach a rack that is incompatible, it could come loose or come off unexpectedly, cause the child to come in contact with moving parts or fall, and lead to severe injury or death.

- If you allow a child to ride in a seat or trailer attached to a bicycle, be extra vigilant to ensure the child's safety. Make sure your bicycle is suitable for the attachment of a child seat or trailer. Trailers should use the flag provided.
- Check its attachment or connection to your bike before every ride.

**⚠ WARNING:** Do not mount a clamp to a bicycle frame that is not equipped for it. The frame material may become damaged resulting in unsafe conditions.

- Luggage carriers (racks) are designed for carrying luggage and not passengers, unless an approved child carrier is used.
- Never carry anything which obstructs your vision or your complete control of the bicycle, or which could become entangled in the moving parts of the bicycle.
- Keep in mind the maximum allowed load of your bicycle when attaching a child seat on a rear rack. On e-bikes with a rear rack battery, the maximum load is lower due to the weight of a battery. The maximum allowed load can be found on the rack or rack support bracket.
- If you attach a child seat to the rear of your bicycle, exposed saddle springs could injure a child's fingers. Cover the springs or use a saddle that does not have springs.

**⚠ WARNING:** Exposed springs on the saddle of any bicycle fitted with a child seat can cause serious injury to the child.

- Never leave a child unattended in a child seat or trailer. The bicycle could fall over and injure the child.
- Make sure the child wears protective gear, especially an approved, properly fitted helmet.
- Frequently check to be sure a child on a trailer (with pedals) is awake and alert.
- Reduce your speed. Read and follow the instructions that came with your child seat or trailer.

## **Accompanying a child riding his/her own bike**

- Make sure your child is dressed properly for riding in bright, highly visible clothing.
- Make sure your child is riding the right size bike, and that the seat and handlebar are properly positioned for maximum comfort and control.

- Sprocket 20" dual position crank arm features adjustable pedal height as kids grow.

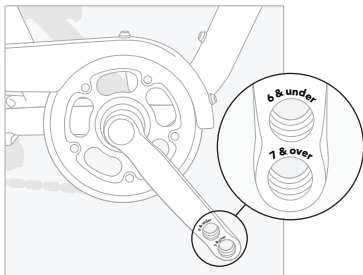

- Children are less likely than adults to recognize hazards and may not respond correctly in an emergency situation, so you'll need to lend your eyes and ears, and judgment to keep them safe.
- Children should not ride near slopes, curbs, stairs, drop-offs, pools, or areas that automobiles use.
- Teach your child the rules of the road and emphasize the importance of obeying them.

- Clearly establish your own riding rules that suit your location, including where, when, and for how long your child can ride.

**⚠ WARNING:** Training wheels prevent the regular lean of a bicycle during a turn. If the child turns too quickly, the bicycle can fall and cause injury. With training wheels, do not permit a child to ride fast or turn suddenly.

- Inspect your child's bicycle before every ride (see section [Before every ride on page 1-13](#)).
- Pay extra attention to the grips and end plugs on the handlebars of your child's bicycle. In the event of a crash, an exposed handlebar end presents a puncture hazard.

**⚠ WARNING:** A handlebar end that is not plugged or covered can cause serious injury or death in a crash. Parents should regularly inspect a child's bicycle and replace damaged or missing grips and end plugs.

## CHAPTER 2

# Caring for your bike

<a href="#">Safeguard your bike .....</a>	<a href="#">2-1</a>
<a href="#">Keep it clean .....</a>	<a href="#">2-1</a>
<a href="#">Part replacement .....</a>	<a href="#">2-1</a>
<a href="#">Parking, storing, and transporting your bike .....</a>	<a href="#">2-2</a>
<a href="#">Maintenance .....</a>	<a href="#">2-5</a>
<a href="#">Inspection .....</a>	<a href="#">2-6</a>
<a href="#">Check tightness .....</a>	<a href="#">2-6</a>
<a href="#">Four easy fixes every rider should know .....</a>	<a href="#">2-10</a>
1. <a href="#">Check your tires .....</a>	<a href="#">2-10</a>
2. <a href="#">Wash your bike .....</a>	<a href="#">2-11</a>
3. <a href="#">Degrease and lube your chain .....</a>	<a href="#">2-11</a>
4. <a href="#">Remove and replace your tire .....</a>	<a href="#">2-12</a>

# Safeguard your bike

We build our bicycles to last a long time – with a little help from you. Follow these safeguards to keep your bicycle in good shape for the long haul.

## Keep it clean

Clean your bicycle with water or mild detergent and a non-abrasive sponge if your bicycle is very dirty. Never spray your bicycle with pressurized water, and never spray directly onto bearing points or electrical parts on e-bikes. Never use harsh chemicals or alcohol wipes to clean your bike. See the [Four easy fixes every rider should know on page 2-10](#) section for more details on washing your bicycle.

## Part replacement

If you need to replace any bike parts (worn brake pads, for example, or broken parts from an accident), visit your bike shop or the Accessories section of [electra.trekbikes.com](http://electra.trekbikes.com).

Use only genuine replacement parts. If you use anything other than genuine replacement parts you may compromise the safety, performance, or warranty of your bicycle.

## A warning about servicing your bike

Special tools and skills are necessary for the servicing of your bicycle. If a repair or adjustment is not specifically listed in this manual, for your safety only your bike shop should make that repair.

## Suggested tools list

Not all these tools are necessary for all bicycles.

- 2, 4, 5, 6, 8mm hex wrenches
- 9, 10, 15mm open-end wrenches
- 15mm box end wrench
- Socket wrench, 14, 15, and 19mm socket
- T25 Torx wrench
- No. 1 Phillips-head screwdriver
- Bicycle inner tube patch-kit, tire pump with gauge, and tire levers
- Torque wrench



**⚠ WARNING:** *Many bicycle service and repair tasks require special knowledge and tools. Do not begin any adjustments or service on your bicycle until you have learned from your bike shop how to properly complete them. We recommend that significant mechanical repairs be carried out by a qualified bicycle mechanic. Improper adjustment or service may result in damage to the bicycle, or an accident that can cause serious injury or death.*

Your safety depends on the correct maintenance of your bicycle. If a repair, adjustment, or software update is not specifically listed in this manual, only your bike shop should make that repair.

After any repair or accessory installation, check your bicycle as shown in the Before every ride section.

## **Parking, storing, and transporting your bike**

### **Prevent theft**

Do not park your bicycle unless you secure it to a fixed object with a bike lock that resists bolt cutters and saws. For an e-bike, lock the battery in place and remove the remote/display, if applicable.

Register your bicycle online (see section Register your bike). Record the serial number in this manual and put the manual in a safe location.

### **Park or store your bike safely**

Park your bicycle where it cannot fall or roll away. Any fall can cause damage to your bicycle or property around you.

Incorrect use of a bicycle parking rack could bend your wheels, damage brake cables, or in the case of e-bikes, damage electric system cables.

Do not rest your bicycle on its derailleurs. The rear derailleur could bend or dirt could get on the drivetrain.

Protect your bike from the elements when possible. Rain, snow, hail, and even direct sunlight can damage your bicycle frame, finish, or parts.

Before you put away your bicycle for an extended time, clean and service it and apply frame polish. Hang your bicycle off the ground with the tires at approximately half the recommended inflation pressure.

See the quick start guide or the supplemental Electric Bicycle Owner's Manual for proper battery storage.

## Protect your bike's finish

The finish or paint on your bicycle can be damaged by chemicals (including some sports drinks) or abrasive contact. Dirt can scratch or remove paint (and even frame material) especially where a cable rubs or a strap is placed around a tube. Use adhesive padding to prevent rubbing in critical spots.

## Use care with car racks, work stands, trailers, and trainers

Clamping devices such as those found on a work stand, car carrier, trainer, or child's trailer can cause damage to bicycle frames. Follow the instructions for your specific accessory to protect your bicycle from harm. Not all bicycles are compatible with a luggage carrier, bicycle trailer, etc.... If you are not sure, ask your bike shop.

**CAUTION:** *When transporting bicycles on a rear bicycle rack on a car, there must be a sufficient distance between the exhaust and the bike wheel(s). The minimum distance is 45 cm (18") behind the exhaust and at least 20 cm (8") above it.*

 **WARNING:** *Adding a child carrier to your bicycle adds weight and raises the center of gravity, which can make the bike take longer to stop, become hard to control, and be easier to tip over. Do not leave your child unattended in a child carrier. Take extra care when balancing, braking, and cornering with a child carrier. Tipping over or loss of control may lead to severe injury or death to you or your child passenger.*

 **WARNING:** *Certain bicycle racks are not intended for use with child carriers. If you are unsure, contact your Electra bike shop.*

**⚠ WARNING:** *Child carrier manufacturers have different mounting systems which may or may not be compatible with certain bicycle racks. If you are unsure, contact the child carrier manufacturer.*

**⚠ WARNING:** *If you attach a rack that is incompatible, it could come loose or come off unexpectedly, cause the child to come in contact with moving parts or fall, and lead to severe injury or death. Package your bicycle carefully for shipping*

## **Package your bike carefully for shipping**

An incorrectly packed bicycle is easily damaged in transit. Always use a rigid case or carton that will protect your bicycle when you package it for shipping. Attach foam pads to all the frame and fork tubes, and use a rigid block to protect the fork tips and maintain structural support of the fork blades.

## **Inspect your bike for any effects after shipping**

1. Unwrap bar tape and inspect the handlebar.
2. Check frame tubes and fork for dents, cracks, or scratches.
3. Follow the bike's online service manual to reassemble or check with your local Electra bike shop for assistance.

There are also special rules and considerations when shipping an e-bike. If you are not sure of what you're doing, see the supplemental Electric Bicycle Owner's Manual at [electra.trekbikes.com](http://electra.trekbikes.com) or ask your bike shop to package your bicycle for you.



[electrabike.com/manuals](http://electrabike.com/manuals)

# Maintenance

Technological advances continue to make bicycles more complex. It's impossible for this manual to provide all the information required to properly repair and maintain every bicycle.

To help minimize the chances of an accident and possible injury, it's critical that you have your bike shop perform any repair or maintenance not specifically described in this manual.

The longer you neglect maintenance, the more it becomes critical. Your bike shop can help you decide your maintenance requirements.

After initial use, new bicycles should be checked. As an example, cables stretch through use, and this can affect the operation of shifting or braking. Approximately two months after you purchase your new bicycle, have your bike shop fully check it. Have your bike shop fully service your bicycle each year even if you did not ride your bicycle much.

Before each ride, perform an inspection as outlined in the **Before every ride** section.

Maintenance schedules are based on normal use. If you ride your bicycle more than the time indicated, perform maintenance more frequently than recommended. If a part malfunctions, check and service it immediately, or consult your bike shop. If a part has wear or damage, replace it before you ride your bicycle again.

If your inspection shows your bike needs maintenance, visit or contact your bike shop for service.

# Inspection

As listed in the Maintenance schedule, perform the following inspections and maintenance when indicated.

## Check tightness

Your new bicycle left the shop with bolts and connections properly tightened – but those bolts and connections may loosen over time. This is normal. It's important to check and adjust them to proper torque specifications.

### Know your torque specs

Torque is a measure of the tightness of a screw or bolt.

Too much torque can stretch, deform, or break a bolt (or the part it attaches). Too little torque can allow the part to move and may lead to fatigue and breakage of the bolt (or the attached part).

A torque wrench is the only reliable method of determining correct tightness. If you do not have a torque wrench, you cannot properly inspect for tightness and should consult your bike shop.

The torque specification is often written on or near the bolt or part. If a part does not have a specification on it, ask your bike shop. It shouldn't take more than a few minutes to check the following and

adjust as necessary to proper torque specs:

- Saddle clamp bolt(s)
- Seatpost clamp bolt
- Stem bolts
- Shift lever attachment bolts
- Brake lever attachment bolts
- Brake bolts, front and rear, including any bolt that attaches a cable housing stop
- Suspension attachment bolts and pivot bolts

## Handlebar

### Check

- That the handlebar grips are secure (they shouldn't move or rotate).
- The handlebar tape (if applicable) and replace if it's loose or worn.
- That any handlebar extensions or bar ends are properly positioned and secure, and that bar caps are secure.

**⚠ WARNING:** *A handlebar end that is not plugged or covered can result in severe injury or death in the event of a crash. Parents should regularly inspect each bicycle and replace damaged or missing grips.*

## Stems

Check that all the bolts are tight. The correct tightness varies according to the type of stem on your bicycle—be sure to follow the torque specifications (typically printed on the stem). If you are unsure of which type of stem your bicycle is equipped with, consult your bike shop.

Direct-connect stems: There must be a minimum of one 5mm spacer below the stem in addition to the bearing cover. For carbon steerer tubes, one spacer is required above and below the stem. There are some slight variation exceptions on select road bikes. If you have questions about your stem or your steerer tube, contact your bike shop.

**NOTICE:** Do not apply grease or assembly paste to the stem or steerer tube. This can travel to the headset bearings and steerer tube causing slippage or damage.

## Brakes

Check the brake pads for wear.

- Rim brakes: If the grooves in the brake pad surface are less than 2mm deep (or 1 mm deep for direct-pull brakes), replace the brake pads.
- Disc brakes: Replace brake pads that are thinner than 1mm.
- Disc brake rotors: Check the thickness/wear of the rotor. The minimum thickness is often printed on the disc.

## Wheels and tires

Check the tires for damage or a worn area. As a tire wears thin, it may become more susceptible to puncture. If a cut goes all the way through the casing, or any casing thread shows through the tread, replace the tire.

Your bike shop should fix or replace loose spokes or spokes with damage.

A word about rim wear. Brake pads remove rim material when you apply the brake. If the brakes remove too much material over time, the rim can become weak and break. Aluminum rim wear-indicators:

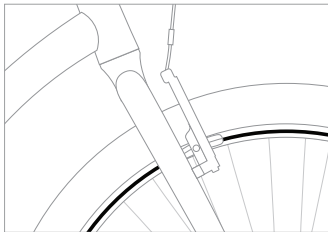

- A shallow groove around the circumference of the rim. If the groove is no longer visible in any spot, replace the rim.
- A dot on the rim – typically near the valve stem. If this indicator is worn such that the dot is no longer visible, replace the rim

If a hub feels loose or makes a grinding noise, your bearings may need attention. Only your bike shop should adjust bearings.

## **Derailleurs**

Shift gears through all the sprocket combinations to make sure the derailleurs operate correctly and smoothly, and the chain does not come off.

## **Pedals**

Wiggle the pedals to make sure they're secure on the crank arms. Rotate the

pedals on the crank arm. If the pedals don't rotate smoothly, see your bike shop to adjust your pedal bearings.

If necessary, tighten your pedals. The right pedal is tightened clockwise. The left pedal is tightened counterclockwise. See your bike shop to tighten your pedals to the correct torque.

## **Crank**

Gently wiggle the crank arms and turn the crank (chainring) with the rear wheel off the ground.

If the crank feels or sounds loose, or if you hear a grinding noise when you turn the crank, do not ride your bicycle. Your bottom bracket (the bearing system that allows the crank arms to turn in the frame) may need adjustment or replacing.

If your inspection shows that your bike needs maintenance, visit the **Support** section on our website for further instructions and helpful videos, or take your bike to your bike shop for service. Only your bike shop should adjust bearings.

## **Chain**

Check the chain for stiff link pins or wear and dirt. Clean and lubricate the chain (see section **Four easy fixes**).

## Accessories

Check all accessories to make sure they're correctly and securely attached.

Some bikes include accessories, such as a kickstand, or you may have added some of your own. Visit the **Support** section on our website for further instructions on operation and maintenance, or follow the instructions that came with your accessories.

## Cables

Check the cables for problems: kinks, rust, broken strands, or a frayed end. Cables should have an end cap to prevent fraying. Also check the cable-housing for loose wire strands, bent ends, cuts, and worn areas. If there is a problem with a cable or housing, do not ride your bicycle. Unless you feel comfortable adjusting your wire cables, take your bicycle to your bike shop for service.

## E-bikes

Check all wires and connectors for damage. Check the operation of the system. Check components such as remote and display for damage. Check the operation of all lights and horn (if applicable).

## Fenders

When mounting a fender, you must coat the top mounting bolt threads with some fresh threadlocking compound, e.g.

Loctite Blue 242 adhesive (or similar) with each installation.

This is for all fork mounting locations: front, rear, or under the fork crown.

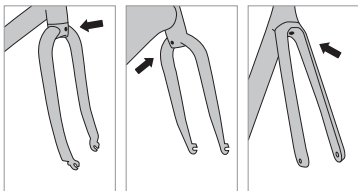

**⚠ WARNING:** *When re-installing a fender, make sure you use all bolt(s) and washers supplied with the bicycle or fender assembly. These bolts and washers have specific sizes and locking capabilities. Failure to properly install these bolts and washers may result in a loose or detached fender contacting the tire causing an abrupt stop.*

**⚠ WARNING:** *Fender mounting bolts may become loose. To avoid loose top bolts, coat the bolt threads with fresh Loctite Blue 242 adhesive (or similar) with each installation. Failure to use an adhesive on the bolts may result in a loose or detached fender contacting the tire causing an abrupt stop.*



# Four easy fixes every rider should know

We know not everybody is mechanically inclined ... but every rider should master these four basic skills. We cover the highlights below, but if you need a little deeper dive, you'll find how-to videos on the Electra Bike YouTube channel: [youtube.com/user/@ElectraBicycleCompany](https://youtube.com/user/@ElectraBicycleCompany).



[youtube.com/user/@ElectraBicycleCompany](https://youtube.com/user/@ElectraBicycleCompany)

## 1. Check your tires

Properly inflated tires make for an enjoyable ride. Checking your tires for inflation and wear is your first step to improve your bicycle's performance.

### Check your tire pressure

Use a tire gauge, or a pump equipped with a gauge, to check your tire pressure.

### Inflate (or deflate) your tires

Use a hand pump to inflate your tires to the air pressure recommended on the sidewall of the tire or to the pressure recommended for the rim, whichever is lower. Make sure your pump is suitable for the bike's Schrader valve.

Do not over-inflate your tires. If your tire is over the recommended range, release air and recheck the pressure.

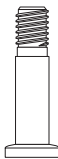

Schrader valve

**NOTE:** It is better to use a hand or foot pump than a service station pump or electric compressor. The latter is more likely to allow for over-inflation, which can cause the tire to blow out.

## 2. Wash your bike

It just feels better to ride a clean bicycle. Not only does it look good, it will also add to the life of the bike. Constant attention to your bicycle's details will keep you up to date with maintenance as well.

All you need is a water hose, a bucket, mild soap, a soft brush, and a towel.

Wet your bicycle with the hose, then work with the brush from the top down using plenty of soapy water. Rinse the soap off and wipe it down.

**NOTICE:** High pressure water may damage bicycle parts. Do not clean your bicycle with a high-pressure washer. High pressure water might also seep into electric connectors, motors, controllers or other parts of the electric system.

## 3. Degrease and lube your chain

Proper lubrication will keep your chain running smoothly and quietly and will prolong the life of your chain. We recommend you clean (degrease) the chain prior to lubrication.

### Degrease

It's a dirty job so leave your dress clothes in the closet. You'll need a bike-specific degreaser (a biodegradable option is good). There are designated chain-cleaner tools, but you can also use a toothbrush.

Apply the degreaser with a toothbrush or a chain-cleaner tool to the bottom length of the chain and pedal backwards. After degreasing, wash the chain with soapy water and a brush, rinse it clean, and allow to dry.

### Lubricate

Use a bicycle-specific chain lubricant. Apply lubricant to each link pin as you slowly pedal backwards. Wipe off any excess lubricant.



**WARNING:** Do not get lubricant on rim sidewalls or disc brake rotors. Lubricant on brake surfaces can cause decreased braking function, and increase the possibility of an accident or injury. Wipe off any lubricant that contacts brake surfaces.

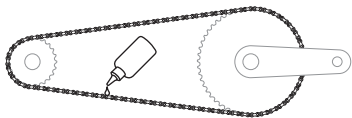

**TIP:** Apply the lubricant to the bottom length of the chain and hold a rag under the chain. This will keep the lube from dripping on your chainstay (frame) or wheel and make the process less dirty.

## 4. Remove and replace your tire

These instructions are written for standard tire systems with tubes. For another type of tire, consult your bike shop or visit the Support section of [electrabike.com](http://electrabike.com).

### Remove the tire from the wheel

1. Deflate the inner tube and loosen the valve nut (Presta or Dunlop valves).
2. Loosen the tire from the rim.
3. Use your hands or tire levers to remove the tire from one side of the rim. Do not use a sharp object such as a screwdriver to remove the tire.
4. With one side of the tire removed,

you can reach in and remove the inner tube.

5. To remove the tire completely use your hands or tire levers to remove the other side of the tire from the rim.

### Replace the tire on the wheel

1. Take this opportunity to examine the tire, rim tape, and the rim for defects.
2. Inflate the inner tube just enough for it to take shape.
3. Place the inner tube in the tire so that it is inside the tire all the way around. Insert the valve stem through the hole in the rim.
4. With your hands only, push one side of the tire over the rim. Make sure the tube is now inside the rim.
5. Push the other side of the tire over the rim.
6. From the outside of the tire, prop the valve stem up through the rim.
7. Inflate the tire to the pressure indicated on the side of the tire. Do not over-inflate.
8. Check to make sure the tire bead is set on the rim.

## **What to do if you suspect your bike may be damaged**

1. Stop riding the bicycle.
2. Take the bicycle to an authorized Electra retailer.
3. Replace the damaged frame or part through your local authorized Electra retailer or shop at [electrabike.com](http://electrabike.com).

## CHAPTER 3

# Reference

[Additional resources](#) ..... 3-1

[Bike diagrams](#) ..... 3-2

# Additional resources

This basic manual is just the beginning. Here's some additional information to help support fun bicycling.

## How-to videos

Electra Bicycle Company has its own YouTube channel: <https://www.youtube.com/@ElectraBicycleCompany> which applies to all bikes and all models.



[youtube.com/user/  
@ElectraBicycleCompany](https://www.youtube.com/user/@ElectraBicycleCompany)

## Warranty

### Electra Care Limited Warranty

#### We've Got You Covered

Every new Electra bicycle comes with our industry's best warranty and loyalty program - Electra Care. Once your Electra bicycle is registered, the Electra Bicycle Company provides each original retail purchaser a warranty against defects in materials and workmanship. For the full warranty statement, please see [electra.trekbikes.com/warranty\\_policy](https://electra.trekbikes.com/warranty_policy).

#### First things first

Contact an authorized Electra retailer or distributor to initiate a warranty claim. Proof of purchase is required.

# Bike diagrams

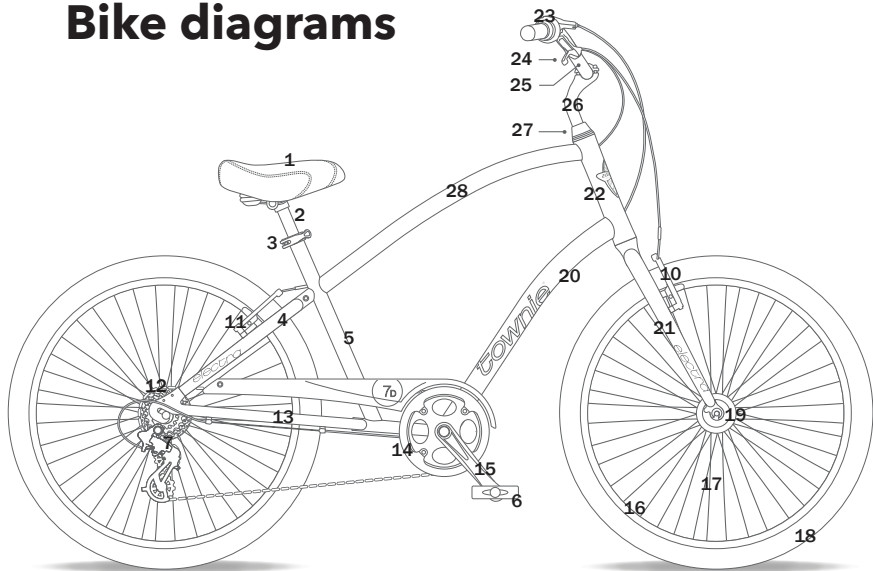

- |                   |                    |              |                |
|-------------------|--------------------|--------------|----------------|
| 1 Saddle          | 8 Front disc brake | 15 Crank arm | 22 Head tube   |
| 2 Seat post       | 9 Rear disc brake  | 16 Rim       | 23 Shifter     |
| 3 Seat post clamp | 10 Front rim brake | 17 Spoke     | 24 Brake lever |
| 4 Seatstay        | 11 Rear rim brake  | 18 Tire      | 25 Handlebar   |
| 5 Seat tube       | 12 Cassette        | 19 Hub       | 26 Stem        |
| 6 Pedal           | 13 Chainstay       | 20 Down tube | 27 Headset     |
| 7 Rear derailleur | 14 Chainring       | 21 Fork      | 28 Top tube    |

These diagrams include basic bike parts. Your specific model may not have all the parts shown. Visit the Support section of [electrabike.com](http://electrabike.com) for more specific information.

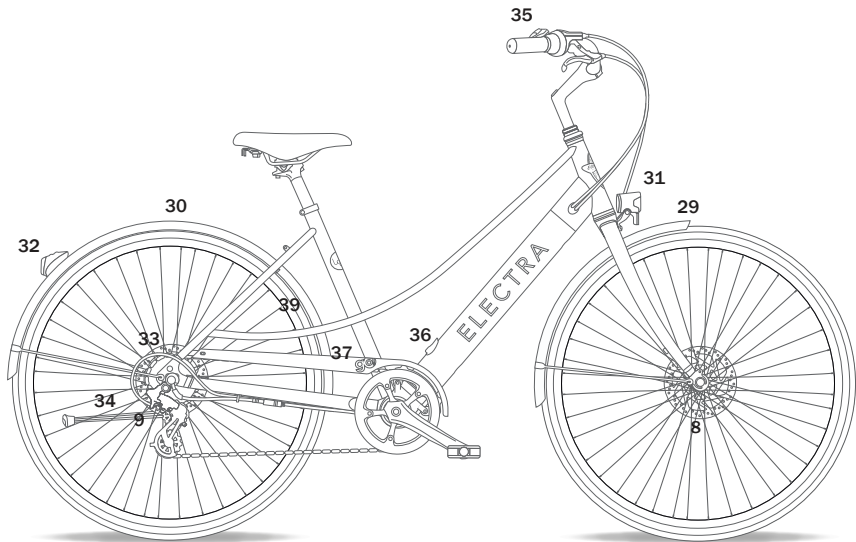

**29** Front fender

**30** Rear fender

**31** Front light

**32** Rear light

**33** Motor

**34** Kickstand

**35** Control unit

**36** Charge port

**37** Chain guard



# Electra Headquarters

## North America

Electra Bicycle Company  
364 2nd Street, Suite 140  
Encinitas, CA 92024  
USA

Customer Service 800-261-1644

## Europe

Bikeurope BV  
Ceintuurbaan 2-20C  
3847 LG Harderwijk  
The Netherlands

## United Kingdom

Trek Bicycle Corporation Ltd.  
9 Sherbourne Drive, Tilbrook  
Milton Keynes, MK7 8HX  
United Kingdom

[customercare@electrabike.com](mailto:customercare@electrabike.com)

**[electrabike.com](http://electrabike.com)**

# Limited lifetime warranty

For more, go to [electrabike.com](https://electrabike.com).

AR	<a href="https://electrabike.com">electrabike.com</a> للمزيد من المعلومات، قم بزيارة موقع	JP	詳しくは、 <a href="https://electrabike.com">electrabike.com</a> をご覧ください。
CS	Více informací naleznete na stránce <a href="https://electrabike.com">electrabike.com</a> .	KO	더 자세한 사항은, <a href="https://electrabike.com">electrabike.com</a> 을 방문하시기 바랍니다.
DA	Få mere at vide på <a href="https://electrabike.com">electrabike.com</a> .	NO	For mer, gå til <a href="https://electrabike.com">electrabike.com</a> .
DE	Weitere Informationen findest du auf <a href="https://electrabike.com">electrabike.com</a> .	NL	Voor meer informatie, ga naar <a href="https://electrabike.com">electrabike.com</a> .
EL	Για περισσότερες πληροφορίες, μεταβείτε στον ιστότοπο <a href="https://electrabike.com">electrabike.com</a> .	PL	Więcej informacji znajduje się na stronie <a href="https://electrabike.com">electrabike.com</a> .
ESES	Para más información, entra en <a href="https://electrabike.com">electrabike.com</a> .	PTBR	Para maiores informações, acesse <a href="https://electrabike.com">electrabike.com</a> .
ESMX	Para más información, ir a <a href="https://electrabike.com">electrabike.com</a> .	PTPT	Para mais informações, visita <a href="https://electrabike.com">electrabike.com</a> .
FI	Lisätietoja saat <a href="https://electrabike.com">electrabike.com</a> -sivustolta.	RU	Подробнее см. на веб-сайте <a href="https://electrabike.com">electrabike.com</a> .
FR	Pour en savoir plus, rendez-vous sur <a href="https://electrabike.com">electrabike.com</a> .	SK	Viac nájdete na stránke <a href="https://electrabike.com">electrabike.com</a> .
HE	<a href="https://electrabike.com">electrabike.com</a> לקבלת מידע נוסף, עבור אל	SL	Več informacij najdete na <a href="https://electrabike.com">electrabike.com</a> .
HR	Za više informacija posjetite <a href="https://electrabike.com">electrabike.com</a> .	SV	Mer information finns på <a href="https://electrabike.com">electrabike.com</a> .
HU	További információért látogasson el a <a href="https://electrabike.com">electrabike.com</a> oldalra.	UK	Щоб дізнатися більше, відвідайте веб-сайт <a href="https://electrabike.com">electrabike.com</a> .
IT	Per scoprire di più, vai su <a href="https://electrabike.com">electrabike.com</a> .	ZH	欲了解更多信息, 请浏览 <a href="https://electrabike.com">electrabike.com</a> 。

To see this manual in your language, go to the [electrabike.com/manuals](https://www.electrabike.com/manuals) page.

<b>AR</b>	قراءة هذا الدليل بلغتك، قم بزيارة صفحة <a href="https://www.electrabike.com/manuals">electrabike.com/manuals</a>	<b>JP</b>	あなたの言語でこのマニュアルを読むには、 <a href="https://www.electrabike.com/manuals">electrabike.com/manuals</a> をご覧ください。
<b>CS</b>	Tuto příručku ve svém jazyce naleznete na stránce <a href="https://www.electrabike.com">electrabike.com</a> /Návody k použití.	<b>KO</b>	해당 설명서를 한국어로 보려면, <a href="https://www.electrabike.com/manuals">electrabike.com/manuals</a> 페이지를 방문하시기 바랍니다.
<b>DA</b>	Du kan se denne brugervejledning på andre sprog på <a href="https://www.electrabike.com/manuals">electrabike.com/manuals</a> .	<b>NO</b>	For å se denne håndboken i ditt språk, gå til <a href="https://www.electrabike.com/manuals">electrabike.com/manuals</a> .
<b>DE</b>	Auf <a href="https://www.electrabike.com">electrabike.com</a> , im Bereich Bedienungsanleitungen findest du dieses Handbuch in deiner Sprache.	<b>NL</b>	Om deze handleiding in uw eigen taal te lezen, ga naar de pagina <a href="https://www.electrabike.com/manuals">electrabike.com/manuals</a> .
<b>EL</b>	Για να διαβάσετε αυτό το εγχειρίδιο στη γλώσσα σας, μεταβείτε στην ιστοσελίδα <a href="https://www.electrabike.com/manuals">electrabike.com/manuals</a> .	<b>PL</b>	Aby znaleźć tę instrukcję w swoim języku, odwiedź stronę <a href="https://www.electrabike.com/manuals">electrabike.com/manuals</a> .
<b>ES</b>	Para consultar este manual en tu idioma, entra en <a href="https://www.electrabike.com/manuals">electrabike.com/manuals</a> page.	<b>PTBR</b>	Para ver este manual em seu idioma, acesse a página <a href="https://www.electrabike.com/manuals">electrabike.com/manuals</a> .
<b>ESMX</b>	Para ver este manual en tu idioma, entra en <a href="https://www.electrabike.com/manuals">electrabike.com/manuals</a> page.	<b>PTPT</b>	Para consultar este manual no teu idioma, vai à página <a href="https://www.electrabike.com/manuals">electrabike.com/manuals</a> .
<b>FI</b>	Löydät tämän oppaan omalla kielelläsi osoitteesta <a href="https://www.electrabike.com/manuals">electrabike.com/manuals</a> page.	<b>RU</b>	Для просмотра этого руководства на вашем языке перейдите на страницу <a href="https://www.electrabike.com/manuals">electrabike.com/manuals</a> .
<b>FR</b>	Pour consulter ce manuel dans votre langue, rendez-vous sur <a href="https://www.electrabike.com/manuals">electrabike.com/manuals</a> .	<b>SK</b>	Na zobrazenie tejto príručky vo vašom jazyku prejdite na stránku <a href="https://www.electrabike.com/manuals">electrabike.com/manuals</a> .
<b>HE</b>	כדי לראות מדריך זה בשפה שלך, עבור לדף <a href="https://www.electrabike.com/manuals">electrabike.com/manuals</a>	<b>SL</b>	Če želite prebrati ta priročnik v svojem jeziku, pojdite na stran <a href="https://www.electrabike.com/manuals">electrabike.com/manuals</a> .
<b>HR</b>	Kako biste ovaj priručnik otvorili na svom jeziku idite na <a href="https://www.electrabike.com/manuals">electrabike.com/manuals</a> page.	<b>SV</b>	Gå till sidan <a href="https://www.electrabike.com/manuals">electrabike.com/manuals</a> om du vill läsa bruksanvisningen på ditt eget språk.
<b>HU</b>	A kézikönyv saját nyelvén való megtekintéséhez látogasson el a <a href="https://www.electrabike.com/manuals">electrabike.com/manuals</a> oldalra.	<b>UK</b>	Цей посібник з експлуатації вашою мовою доступний на веб-сторінці <a href="https://www.electrabike.com/manuals">electrabike.com/manuals</a> .
<b>IT</b>	Per leggere questo manuale nella tua lingua, vai su <a href="https://www.electrabike.com/manuals">electrabike.com</a> , alla pagina <a href="https://www.electrabike.com/manuals">electrabike.com/manuals</a> .	<b>ZH</b>	要查看您所用语言版本的本手册，请浏览 <a href="https://www.electrabike.com/manuals">electrabike.com/manuals</a> 页面。